

Рис. 2

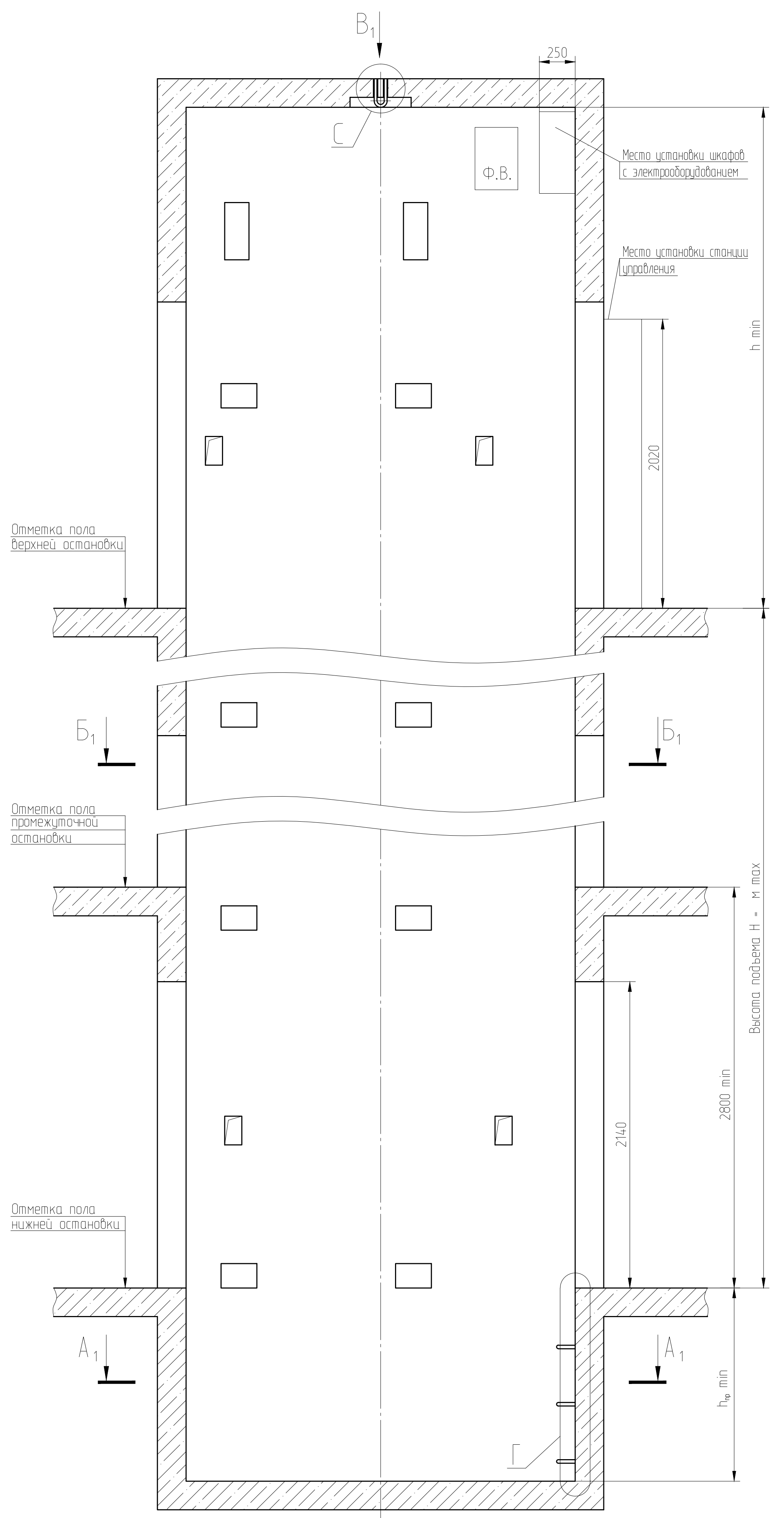

А₁-А₁
Рис. 1.1



Рис. 1.2



П (1:10) (2,4)

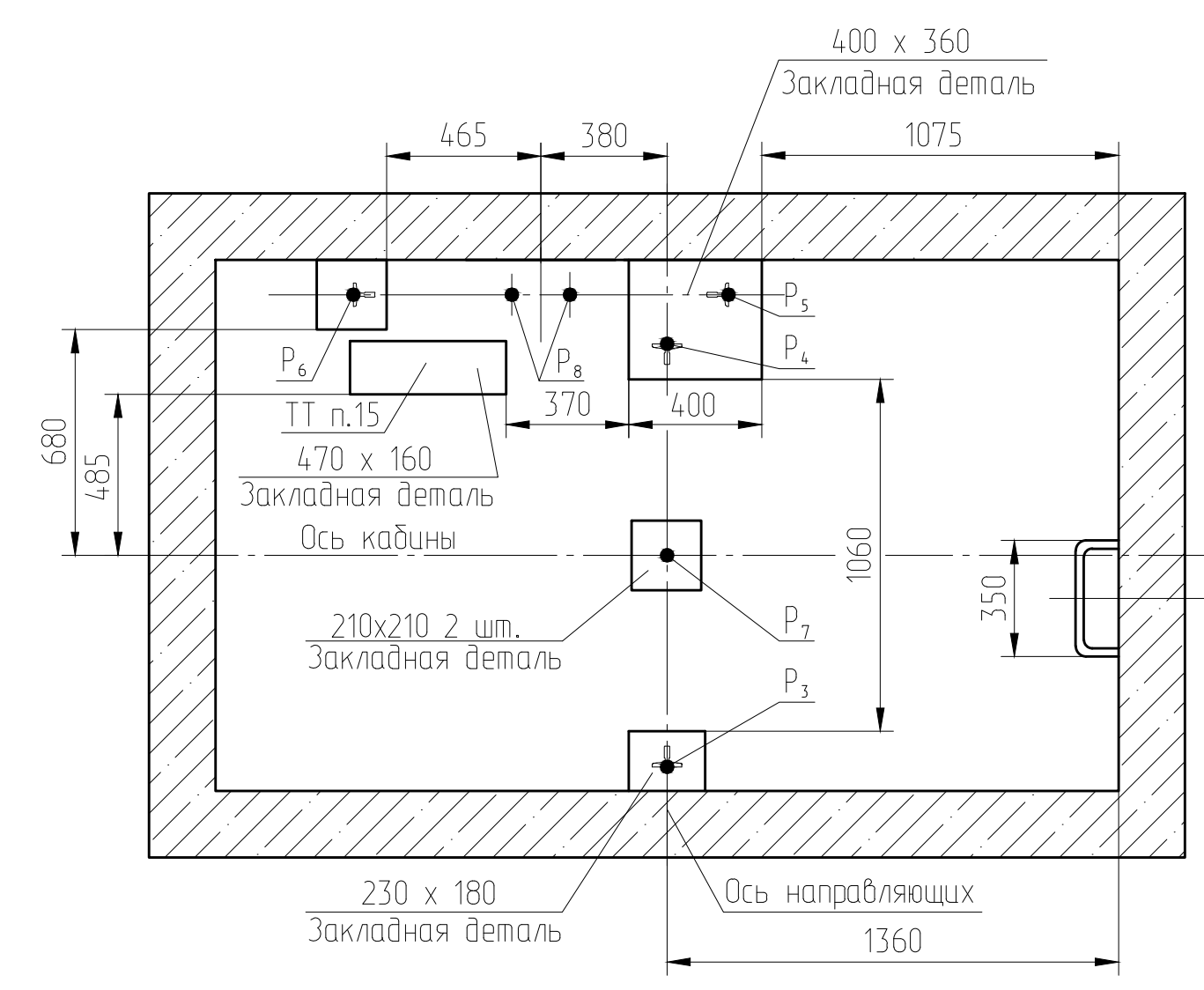
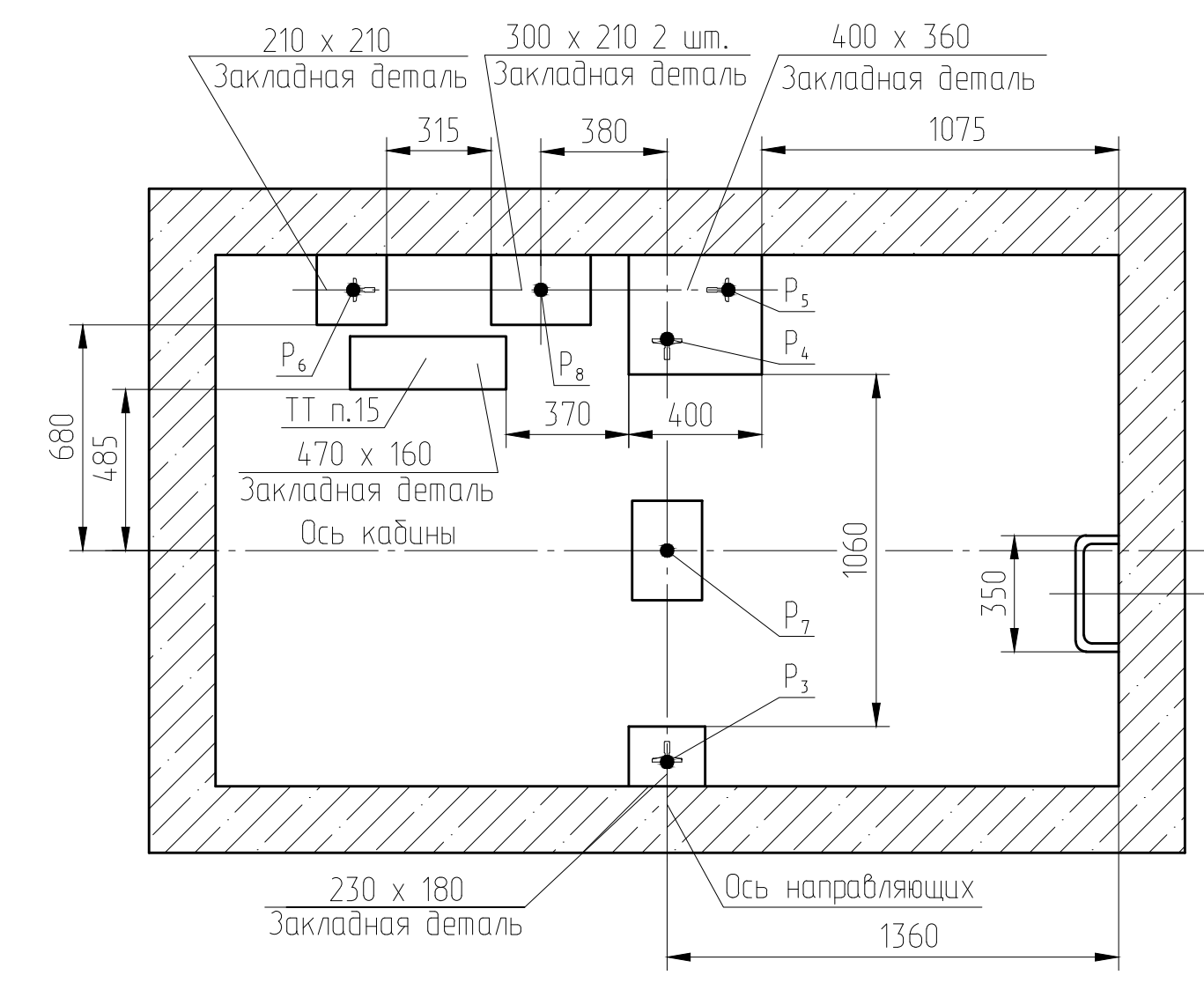
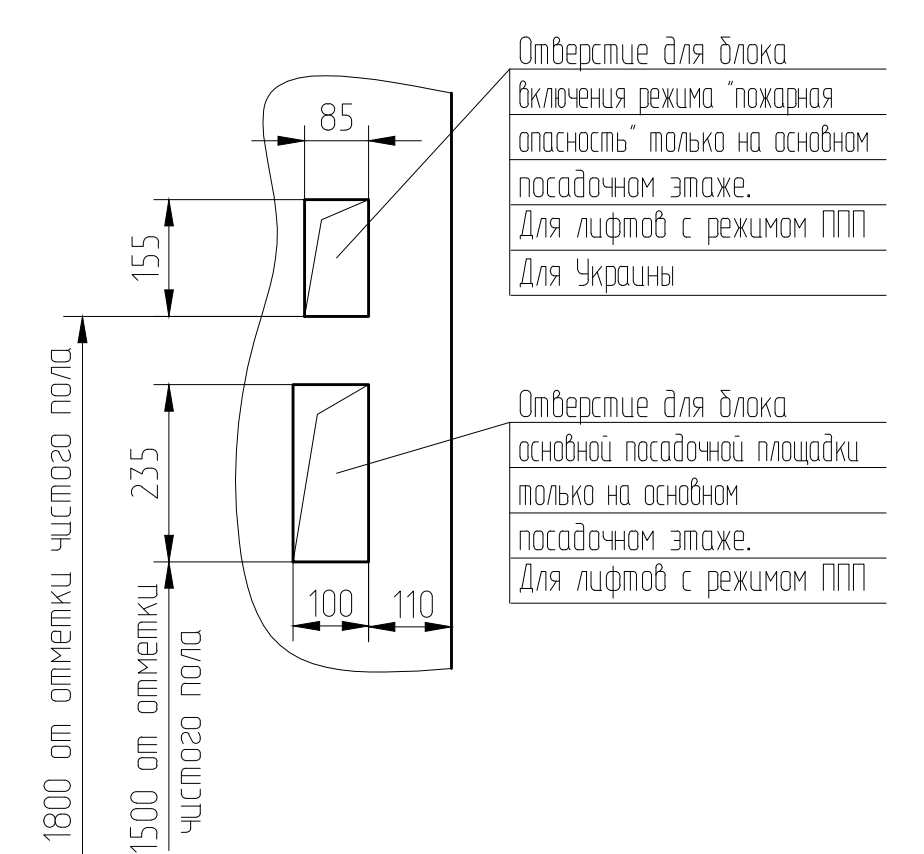

Л-Л (1:10) (2, 4)

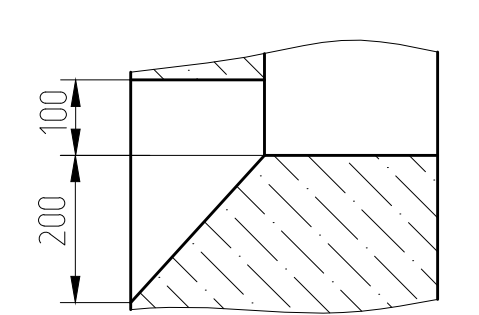

Б₁-Б₁

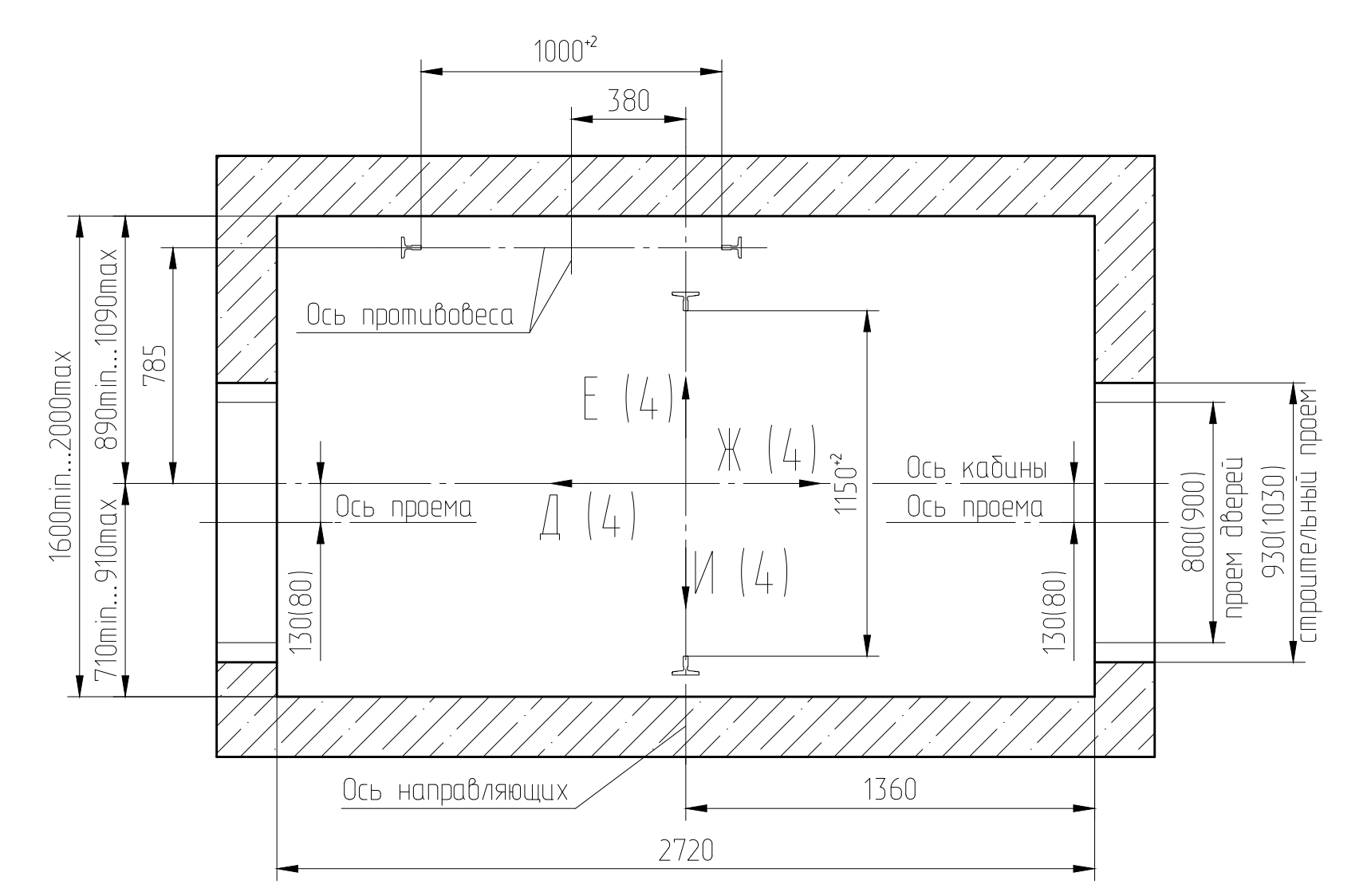

С

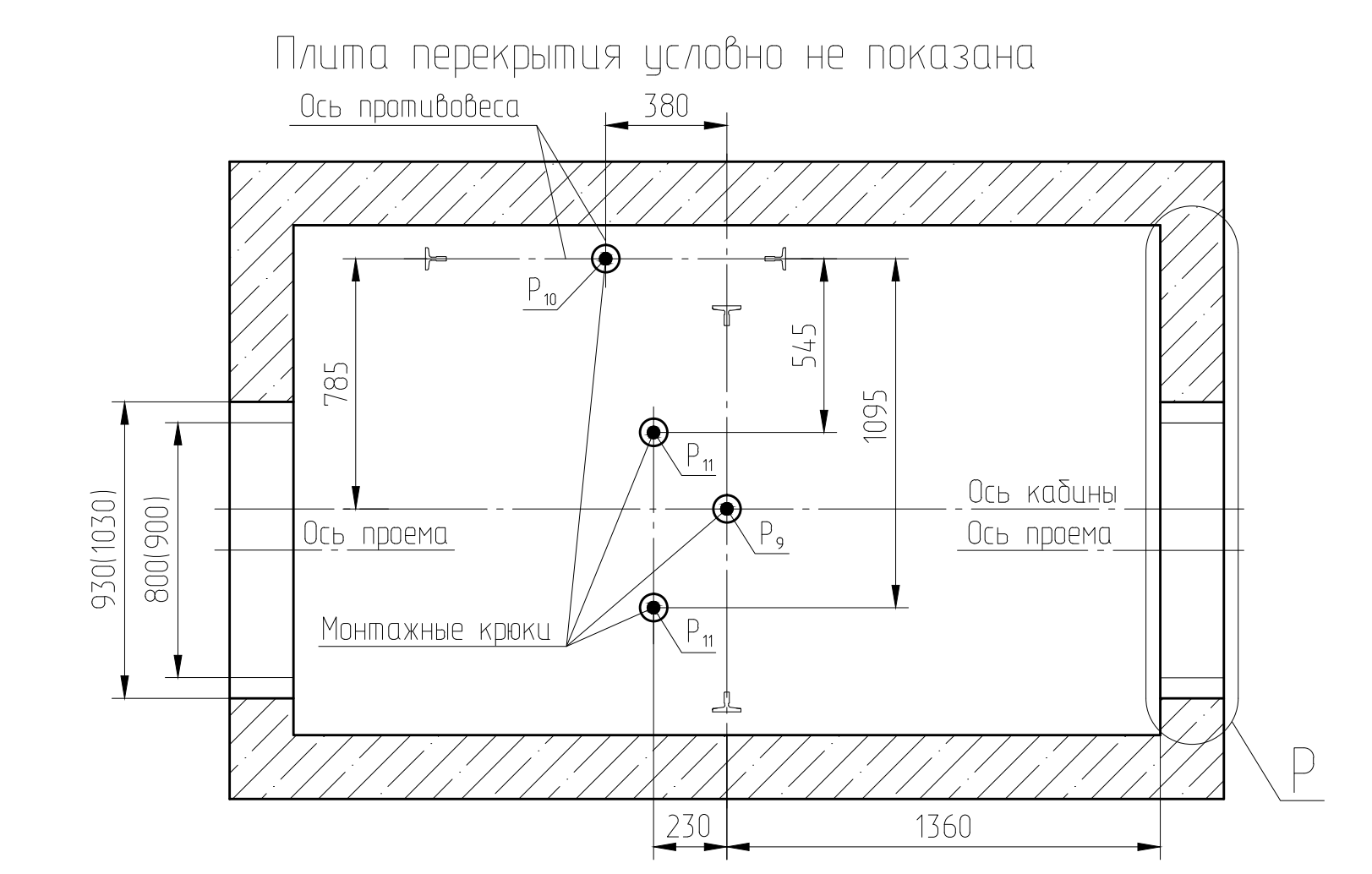

Р (1, 3)

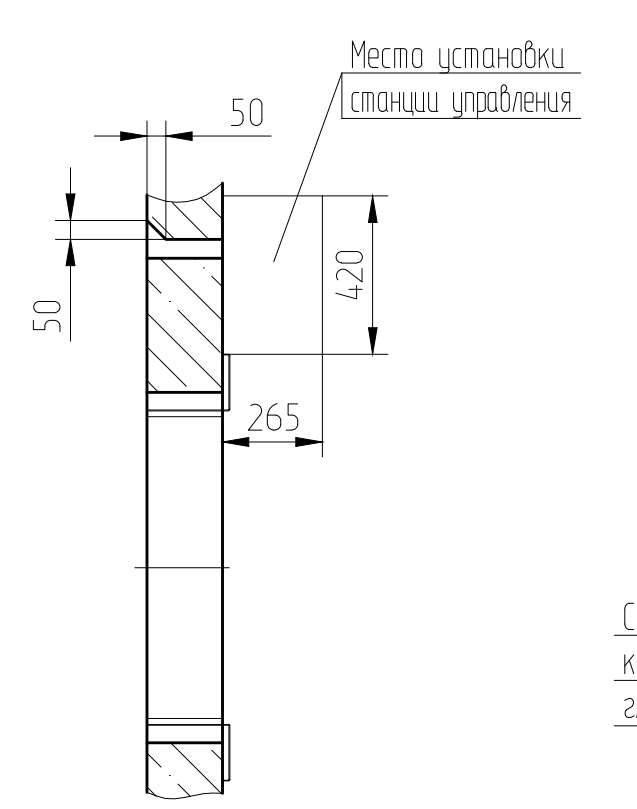

Г (1, 3)

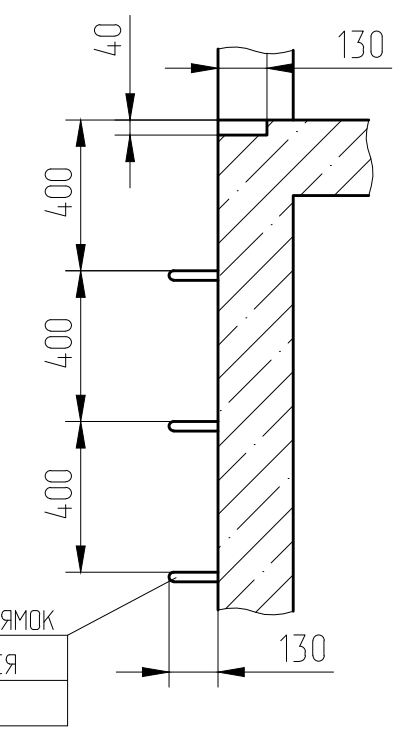

К-К (1:5) (2,4)

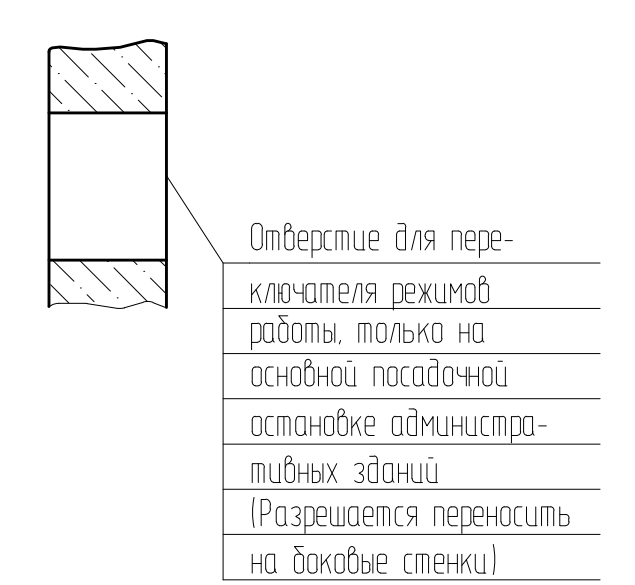

С (1:5) (1,3)



Рис. 2

Д₁ (1:25) (3)

Е₁ (1:25) (3)

Ж₁ (1:25) (3)

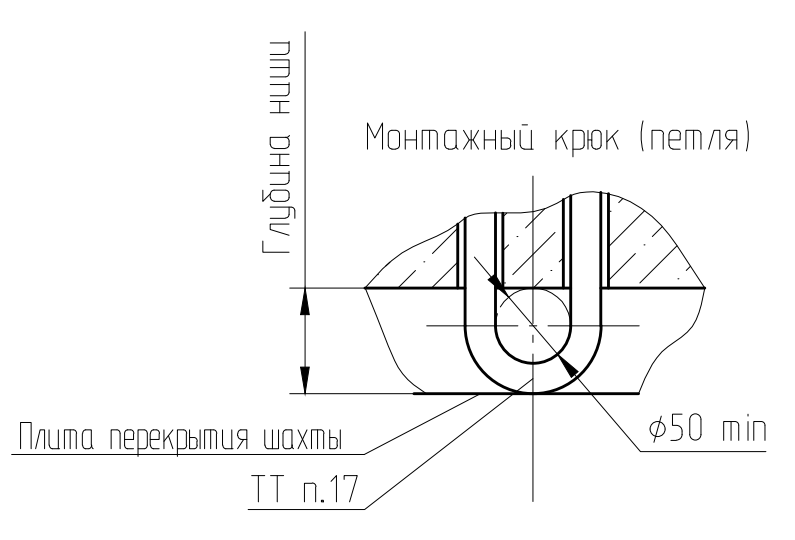
И₁ (1:25) (3)

АС-1.0-ПБА1010ГТ

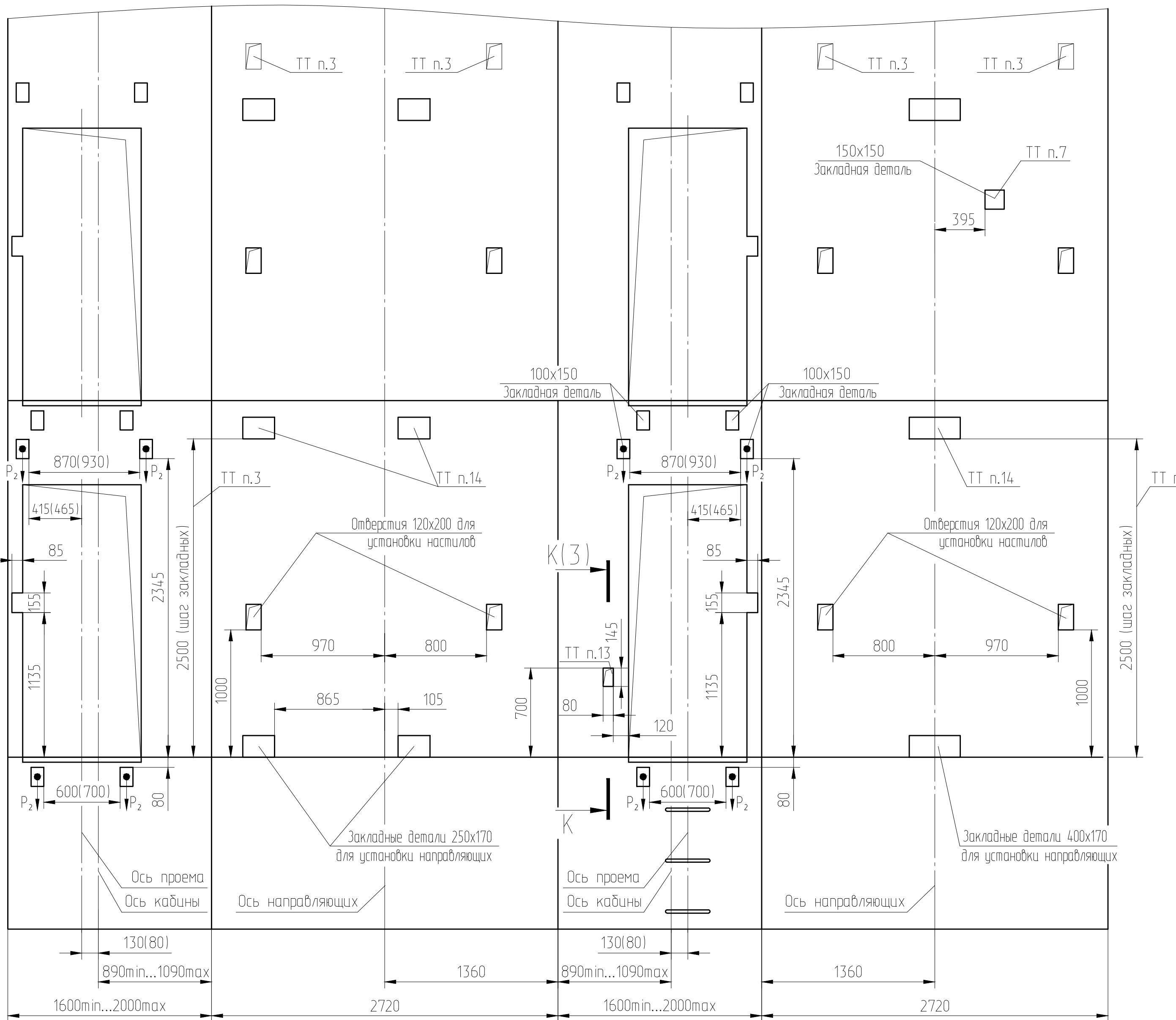
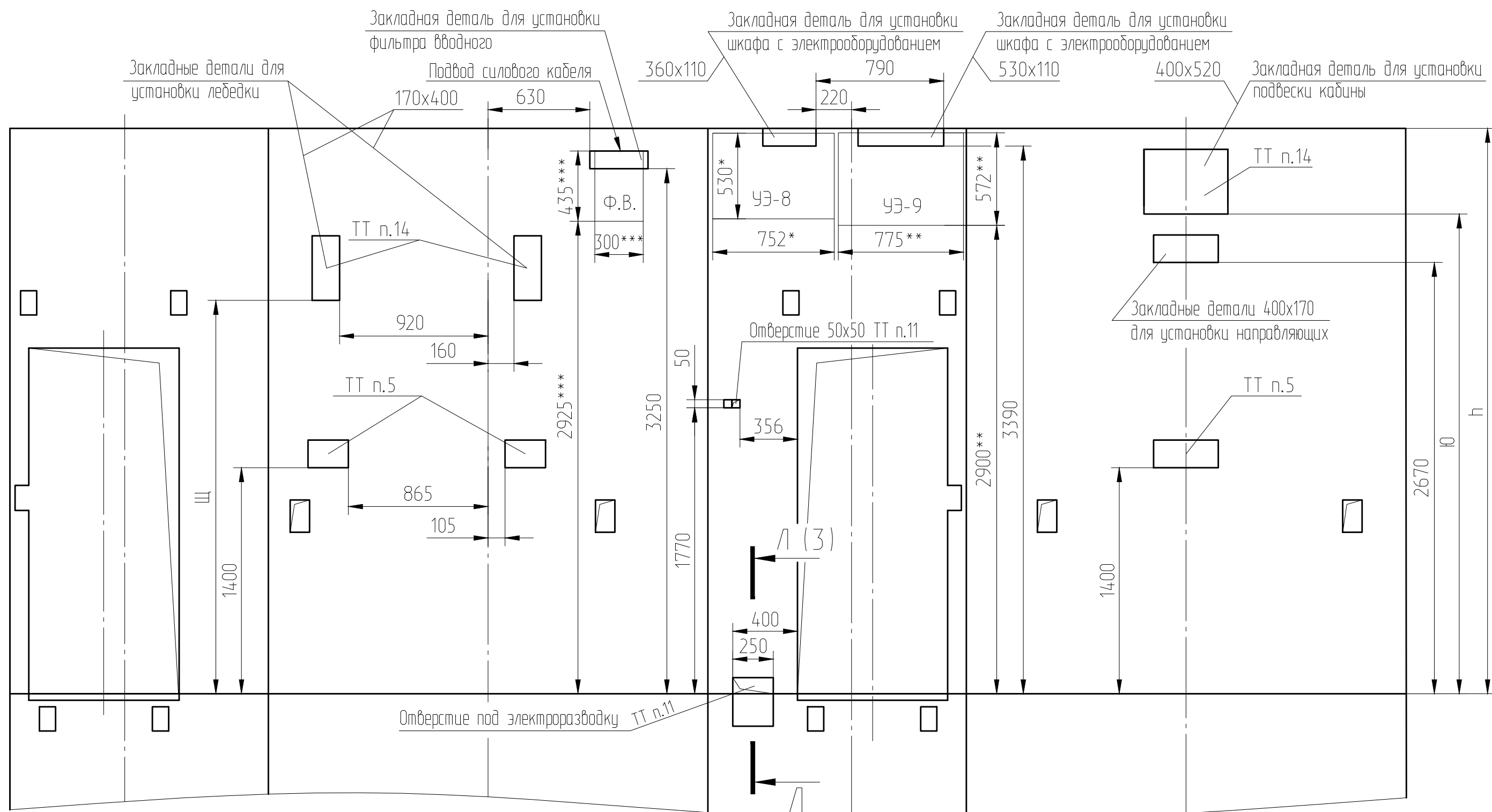

Инв. №локл.	Подп. и дата	Взам. инв. №	Инв. № дубл.	Подп. и дата	Справ. №	Перв. примен.

